



# HEIDENHAIN



Product Information

## **MSE 1000**

Modular Electronic Unit  
for Multipoint Inspection  
Apparatuses

May 2013

# MSE 1000

## Modular electronic unit for multipoint inspection apparatuses

Production-integrated measurement is one of the central demands of modern manufacturing. Unlike a total measurement on a coordinate measuring machine in a separate room, special measuring apparatuses in the production department can minimize the duration of measurement and enable the operator to rapidly adapt processes based on the measurement results. At the same time, such measuring apparatuses—which can be designed as stations for statistical process control (SPC)—also serve for statistical evaluation of the measured values and thus permit a qualified process control. They can be equipped with a large number of differing measuring devices.

The following stringent requirements for the subsequent electronics can be met with the MSE 1000 modular electronic unit from HEIDENHAIN:

- Flexibility for adaptation to differing conditions of operations
- A variety of interfaces for connection of numerous measuring devices
- Fast communication with higher-level computer systems over Ethernet
- Outputs for controlling sorting switches, warning lamps, PLC, etc.
- Output of measurement results for documentation and further processing

### Design

The user installs the MSE 1000 as a series of modules and configures it for his specific requirements. The individual modules permit connection of incremental, absolute and analog measurands, the output of switch signals, and communication over diverse interfaces. In all, up to 250 axes or channels can be configured. In its basic configuration, the MSE 1000 consists of a power module and a basic module. It can be expanded by further modules as needed.

### Mounting

The MSE 1000 modules are easily mounted on a standard rail in a cabinet or on a mounting bracket (accessory). The individual modules are plugged onto each other and fixed together with a lock. This also connects the internal bus and the power supply. The module widths are selected so that the MSE 1000 is also suitable for a 19" housing.

### Functions

The functions of the MSE 1000 are defined by the PC software used.

### MSEsetup

This software package is available for download on [www.heidenhain.de](http://www.heidenhain.de). It handles the basic functions of the MSE 1000:

- Configuration (modules, encoder inputs, data transmission)
- Diagnostics
- Data transfer to the PC
- Writing the measured values to an Excel table

### Program library

The program library (DLL) for Windows systems is required if the MSE 1000 is to be operated with a customer-specific software application. The Ethernet Program Library provides functions that permit communication between the MSE 1000 and PC.

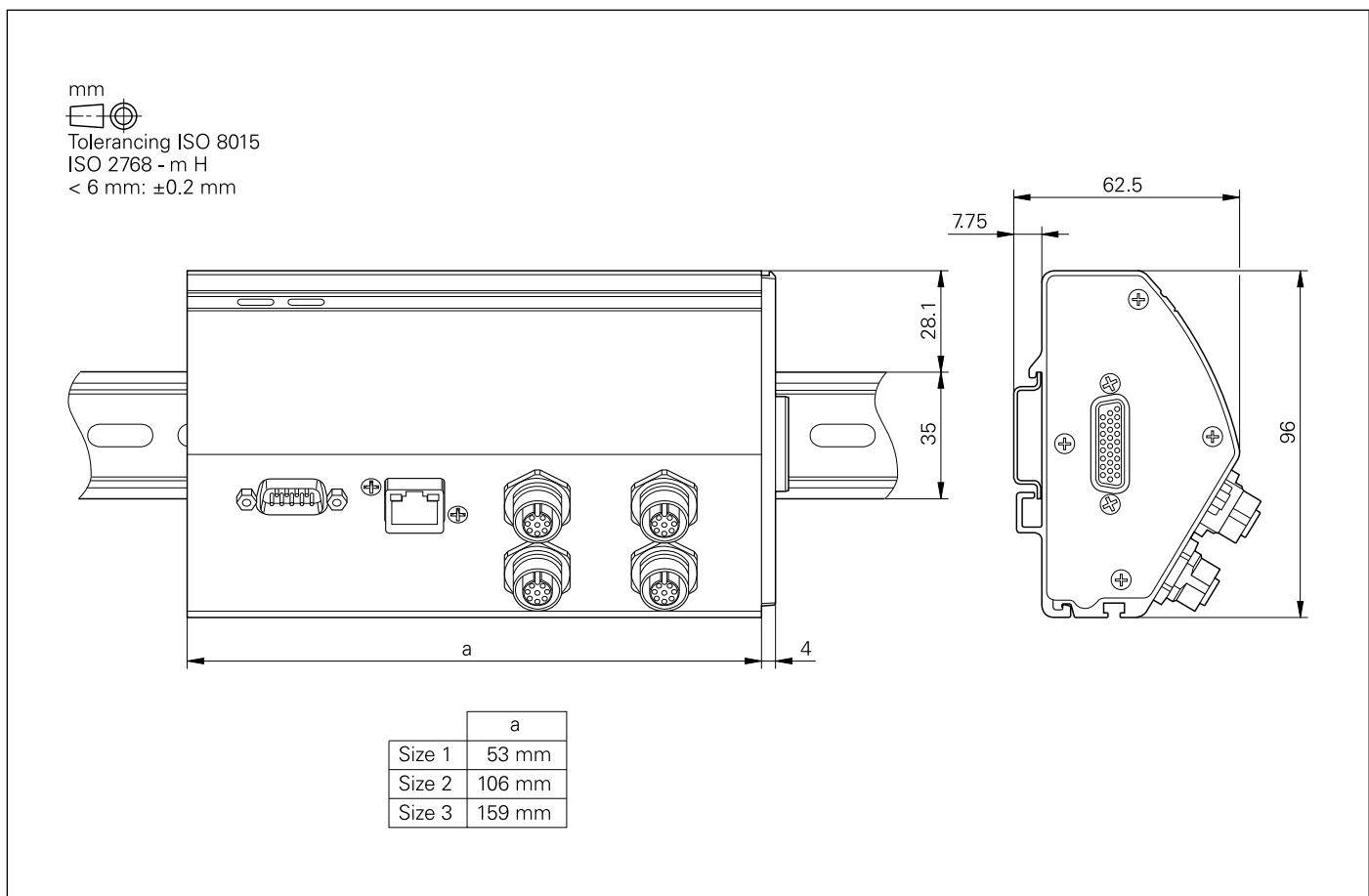

# Modules

Modules		Description	Interface	Connections	Protection	Width a	Power consumption <sup>1)</sup>	Model
Required	Basic	Basic unit with complete functionality • Ethernet 10/100 for connection to the PC • Encoder inputs • Switching inputs $\square$ TTL (e.g. latch)	4 encoders EnDat 2.2	M12, 8-pin, female	IP 65	159 mm	3.5 W	MSE 1114
			4 encoders $\sim 1 V_{PP}$	D-sub, 15-pin, female	IP 65		3.8 W	MSE 1184
			4 encoders <sup>4)</sup> $\square$ TTL	D-sub, 9-pin, female	IP 65		To be determined	MSE 1124
	Power supply	Power supply unit Output power 50 W	100 to 240 V AC	Power plug	IP 40	159 mm	–	MSE 1201
				PG cable gland <sup>3)</sup>	IP 65			
		Power supply unit Output power 70 W	24 V DC	M8, 3-pin, female	IP 65			MSE 1202
Optional	EnDat	Bidirectional encoder interface (purely serial)	4 encoders EnDat 2.2	M12, 8-pin, female	IP 65	106 mm	3.3 W	MSE 1314
			8 encoders EnDat 2.2		IP 65	159 mm	4.4 W	MSE 1318
	Sinusoidal	Counter module for incremental encoders	4 encoders $\sim 1 V_{PP}$	D-sub, 15-pin, female	IP 65	106 mm	3.5 W	MSE 1384
			8 encoders $\sim 1 V_{PP}$		IP 65	159 mm	5.0 W	MSE 1388
	Square-wave	Counter module for incremental encoders	4 encoders <sup>4)</sup> $\square$ TTL	D-sub, 9-pin, female	IP 65	106 mm	To be determined	MSE 1324
			8 encoders <sup>4)</sup> $\square$ TTL		IP 65	159 mm	To be determined	MSE 1328
	Analog	Axis module for analog inputs	2 inputs $\pm 10 V$ or 4 to 20 mA <sup>4)</sup>	D-sub, 9-pin, female	IP 65	106 mm	3.2 W	MSE 1332
	I/O	Floating inputs/outputs	4 relay outputs 4 TTL switching inputs	Terminal block	IP 40	106 mm	6.1 W <sup>2)</sup>	MSE 1401
				M8, 3-pin, female (3 connectors included in delivery)	IP 65			
	for compressed air	Air switch for activation of pneumatic length gauges	1 input 1 output for compressed air	Plug-in connections for 4 mm tube	IP 65	106 mm	3.7 W <sup>2)</sup>	MSE 1501

Modules providing connection to further encoders and interfaces are planned.

<sup>1)</sup> Power consumption of the module. Connected encoders must be considered additionally

<sup>2)</sup> With outputs under load

<sup>3)</sup> Three-meter power cable with PG gland included in delivery

<sup>4)</sup> Available in 04/2013

# Specifications

	Specifications
<b>Measuring channels/axes</b>	Up to 250
<b>Data transfer rate</b>	20 to 100 measured values per second for all axes; depends on the configuration
<b>Data transfer</b>	Standard Ethernet, IEEE 802.3
<b>Addressing</b>	Fixed IP address or DHCP
<b>External latch inputs</b>	2 (e.g. for foot switch)
<b>Software</b>	<p><b>MSEsetup:</b> Graphic-supported configuration of the system, diagnosis of the encoders, loading of measured data to Excel</p> <p><b>Program library</b> for Windows (Linux and LabVIEW in preparation): Integration of the MSE 1000 in the Ethernet network for customer-specific software solutions</p>
<b>Power supply*</b>	100 to 240 V AC or 24 V DC
<b>Operating temperature</b>	0 °C to 45 °C
<b>Relative humidity</b>	≤ 80 %
<b>Degree of protection*</b>	IP 40, optionally IP 65
<b>Mounting</b>	Top hat rail, on mounting bracket or in electrical cabinet (specially conceived for 19-inch cabinet)
<b>Accessories</b>	Mounting bracket, foot switch, connecting cable

\* Please select when ordering

## Example of power consumption calculation

The power supply module (MSE 1201, MSE 1202) provides the electrical power for further modules and encoders. If the power provided does not suffice to operate the desired system configuration, a further power supply module must be used.

The power consumption is specified for each module (see table). The power consumption of the connected HEIDENHAIN encoders can be calculated from the catalog data (supply voltage x current consumption). For all other consumers (e.g. inductive and analog sensors), the connected load must be known. The sum power of all consumers must not exceed the rated power of the power supply module(s).

The following example illustrates this calculation.

## Components to be supplied

Encoders: 8 x ACANTO AT 1217, 12 x SPECTO ST 1288, 2 x LS 388 C,  
2 x temperature sensors 20 V/100 mA  
Modules: 1 x MSE 1114 basic module, 1 x MSE 1314 axis module,  
2 x MSE 1388 axis modules, 1 x MSE 1501 compressed-air module,  
1 MSE 1332 analog module

## Power calculation

	Data from catalog and calculated				Total power consumption (example)
	Operating voltage	Current consumption	Power consumption/unit	Number of units	
<b>ACANTO AT 1217</b>	5 V	150 mA	0.75 W	8	6 W
<b>SPECTO ST 1288</b>	5 V	90 mA	0.45 W	12	5.4 W
<b>LS 388 C</b>	5 V	100 mA	0.5 W	2	1 W
<b>Thermistor</b>	20 V	100 mA	2 W	2	4 W
<b>MSE 1114</b>	–	–	3.5 W	1	3.5 W
<b>MSE 1314</b>	–	–	3.3 W	1	3.3 W
<b>MSE 1388</b>	–	–	5 W	2	10 W
<b>MSE 1501</b>	–	–	3.7 W	1	3.7 W
<b>MSE 1332</b>	–	–	3.2 W	1	3.2 W
<b>Total:</b>					40.1 W



This power consumption can be met by **one** MSE 1201 (50 W) or MSE 1202 (70 W) power supply module.



# Interfaces

## Encoders

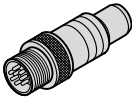
### EnDat pin layout

Mating connector:  
8-pin coupling, M12





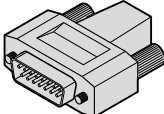
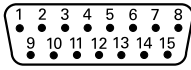

	Power supply				Absolute position values			
	8	2	5	1	3	4	7	6
	$U_P$	Sensor $U_P$	0V	Sensor 0V	DATA	$\overline{\text{DATA}}$	CLOCK	$\overline{\text{CLOCK}}$
	Brown/Green	Blue	White/Green	White	Gray	Pink	Violet	Yellow

### Pin layout $\sim 1V_{pp}$

Mating connector:  
15-pin D-sub connector





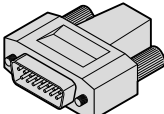
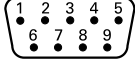

	Power supply				Incremental signals						Others		
	4	12	2	10	1	9	3	11	14	7	5/6/8/15	13	/
	$U_P$	Sensor $U_P$	0V	Sensor 0V	A+	A-	B+	B-	R+	R-	Vacant	Vacant	Vacant
	Brown/ Green	Blue	White/ Green	White	Brown	Green	Gray	Pink	Red	Black	/	Violet	Yellow

### Pin layout $\square$ TTL

Mating connector:  
9-pin D-sub connector (male)





	Power supply		Incremental signals						Others	Shield
	7	6	2	3	4	5	9	8	1	Housing
	$U_P$	0V	$U_{a1}$	$\overline{U_{a1}}$	$U_{a2}$	$\overline{U_{a2}}$	$U_{a0}$	$\overline{U_{a0}}$	Vacant	Case GND
	BN/GN+BL	WH/ GN+WH	Brown	Green	Gray	Pink	Black	Red	/	

### Analog pin layout

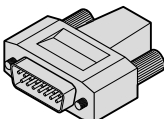
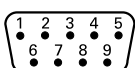
Mating connector:  
9-pin D-sub connector (male)

	Power supply 1			Power supply 2		Shield		Analog signal		
	1	4	3	9	6	5	Housing	8	2	7
TTL	-12V	+12V	0V	5V	0V	Shield	Case GND	$U_A$	$I_A$	$\overline{I_A}$

Power supplies 1 and 2 are galvanically isolated and must not be used simultaneously.

$U_A$ : Analog voltage signal - 10V to + 10V;  $I_A$ : Analog voltage signal 4 to 20 mA

**Cable shield** connected to housing;  $U_P$  = Power supply voltage

**Sensor:** The sensor line is connected in the encoder with the corresponding power line.

Vacant pins or wires must not be used!

# Inputs/Outputs

## Relay outputs

### Specifications

$U_L \leq 30 \text{ V DC/AC}$   
 $I_L \leq 0.05 \text{ A}$   
 $t_D \leq 25 \text{ ms}$

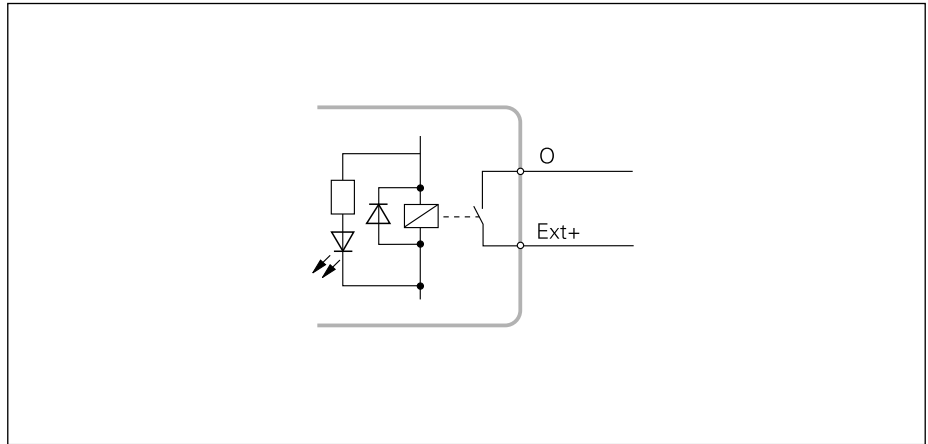

## Switching inputs

The switching inputs are active when a High signal (contact or pulse) is present. They are isolated and can be supplied externally or internally.

### Specifications

$0 \text{ V} \leq U_L \leq 1.5 \text{ V}$   
 $4.5 \text{ V} \leq U_H \leq 26 \text{ V}$   
 $I_L \leq 25 \text{ mA}$   
 $t_{min} \geq 100 \text{ ms}$

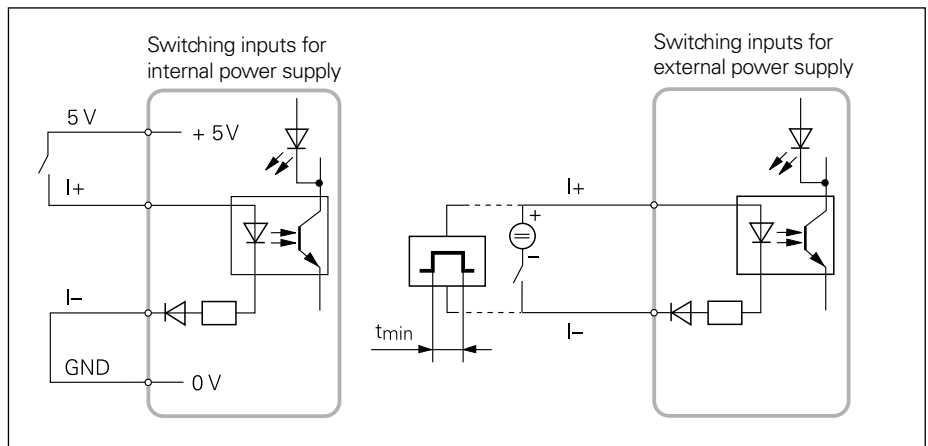

Relay outputs and switching inputs are integrated in the MSE 1401 input/output module. It is available in two versions.

**IP 40 protection** Electrical connections as terminals

**IP 65 protection** Electrical connections as individual M8 connecting elements

## IP 40 terminal block

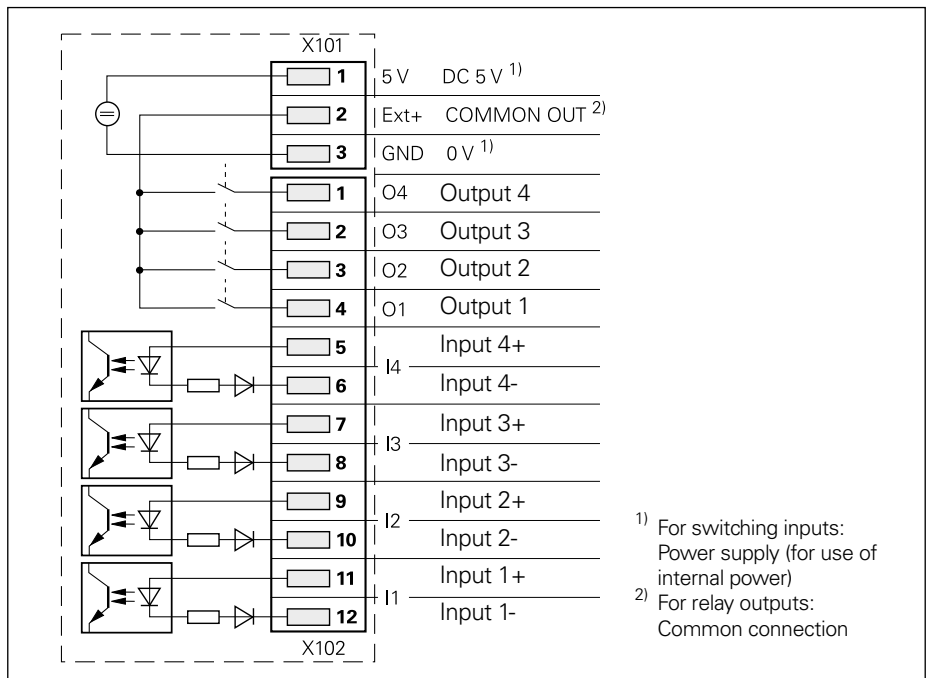

### IP 65 relay outputs

Mating connector  
3-pin M8 coupling (female)

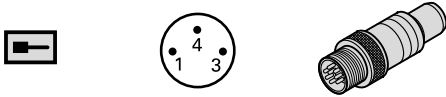

PIN	Assignment	
1	O	Output
3	Vacant	
4	Vacant	

### IP 65 relay inputs

Mating connector  
3-pin M8 coupling (female)

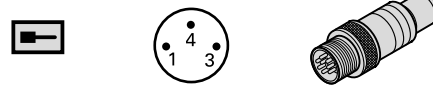

PIN	Assignment	
1	I+	Input
4	I-	
3	Vacant	

### IP 65 power supply

Mating connector  
3-pin M8 connector (female)

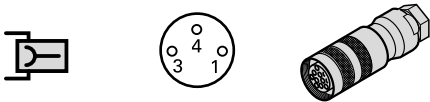

PIN	Assignment	
1	5 V DC	<i>For switching inputs:</i> Power supply (for the use of internal power)
4	0 V	
3	COMMON OUT	<i>For relay outputs:</i> Common connection

## Power supply unit

The MSE 1202 power-supply module with 24 V DC supply has an M8 connector

Mating connector  
3-pin M8 connector (female)

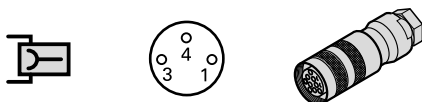

PIN	Assignment	
1	24 V DC	Power supply
3	0 V	
4	Vacant	

# Accessories

## Mounting bracket

For mounting the MSE on a (table) surface. Two mounting brackets are connected together by two standard top hat rails. Two rows of modules or one MSE can be connected to it and a cable channel can be fastened.

ID 850752-01

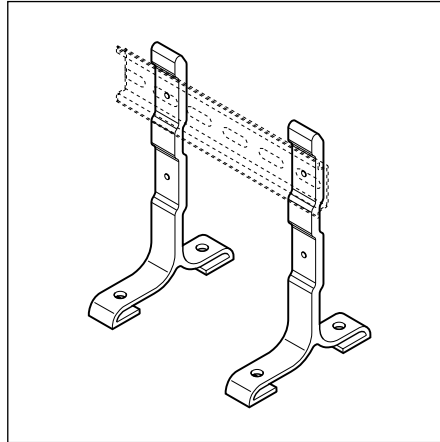

## Foot switch

For connection to the basic module, for triggering/latching measurements.

Cable length: 4.5 m

ID 681041-03

## Mating connector

3-pin M8-coupling (male)  
for In- and Outputs MSE 1401 IP 65  
ID 1071953-01

3-pin M8-connector (female)  
for power supply of MSE 1202 and  
MSE 1401 IP 65  
ID 1071955-01

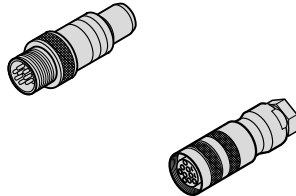

## Connecting cable

For connecting two or more MSE rows, e.g. during mounting in the electrical cabinet.

ID 850753-xx

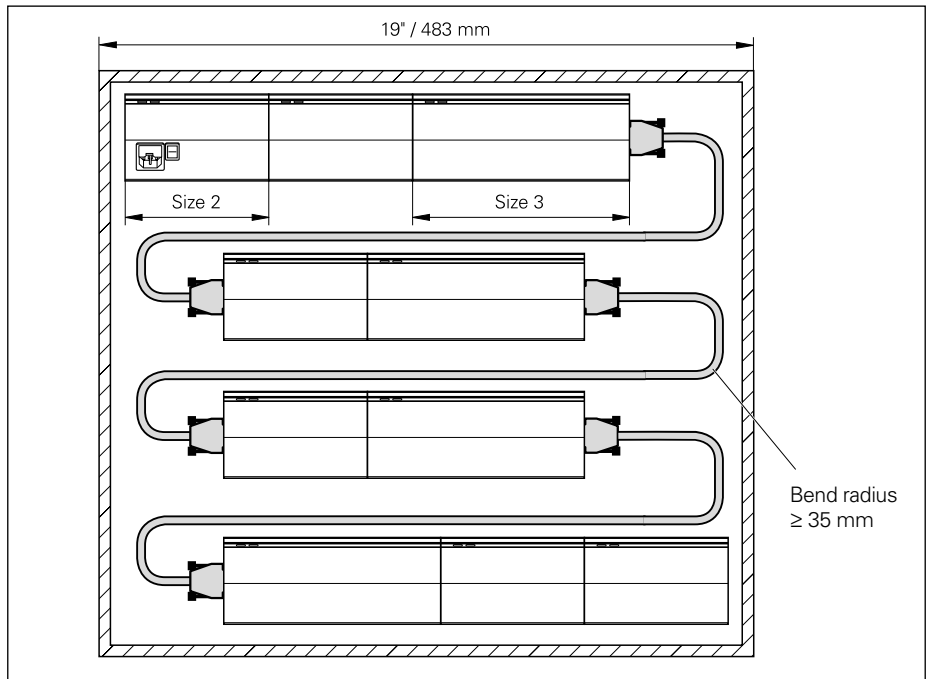

**HEIDENHAIN**



**Q-PLUS LABS**

13765-E Alton Pkwy

Irvine, CA 92618

(949) 380-7758

[www.qpluslabs.com](http://www.qpluslabs.com)